



TAGLIAVERDURE ÉLITE TAGLIAVERDURE ÉLITE ^{PRO}

ÉLITE VEGETABLE SHREDDER
ÉLITE VEGETABLE SHREDDER ^{PRO}



Made in Italy





TAGLIAVERDURE ÉLITE

ÉLITE VEGETABLE SHREDDER

PRODUZIONE ORARIA
250 / 450 KG/H
PRODUCTION PER HOUR
250 / 450 KG/H

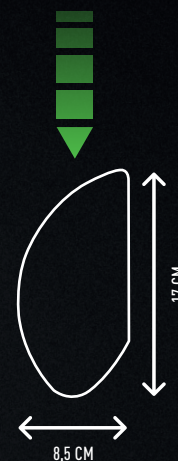

INGRESSO CAPACITÀ
STANDARD
STANDARD CAPACITY INLET

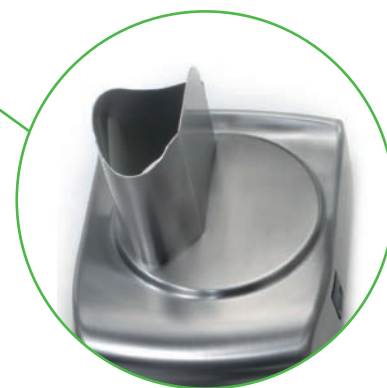

INGRESSO
CAPACITÀ STANDARD
STANDARD
CAPACITY INLET



CARATTERISTICHE STANDARD

- Macchinario per uso professionale
- Vasta scelta di dischi dal più semplice al più creativo
- Cambio dischi semplice e rapido
- Carena in acciaio inox 304
- Coperchio in acciaio inox e vaschetta di taglio facilmente rimovibili per una più semplice e accurata pulizia
- Bocca di scarico inclinata per una maggior produttività
- Maniglia ergonomica con funzione start/stop e bloccaggio in posizione di carico
- Tutte le parti a contatto con gli alimenti sono in acciaio inox o plastica alimentare
- Tastiera digitale con indicazioni luminose a led
- Comando ad impulsi per una maggiore precisione di taglio
- Motore potente e ventilato adatto ad un uso intensivo
- Trasmissione a cinghia
- Microinterruttore di protezione
- Pestello in ABS
- Facile da smontare e pulire
- Dispositivi di sicurezza a norma CE per la massima protezione dell'operatore
- Fabbriato in Italia

SINCE
1953

MADE
IN ITALY



TAGLIAVERDURE ÉLITE PRO

ÉLITE VEGETABLE SHREDDER PRO



PRODUZIONE ORARIA
450 / 600 KG/H
PRODUCTION PER HOUR
450 / 600 KG/H

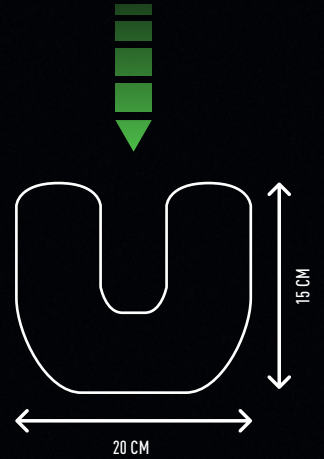

INGRESSO AD
ALTA CAPACITÀ
HIGH CAPACITY INLET



INGRESSO AD
ALTA CAPACITÀ
HIGH CAPACITY INLET

MAIN FEATURES

- Professional heavy duty equipment
- Full range of cutting, slicing and grating discs available
- Fast blade change
- AISI 304 S/steel casing
- Frame and lid made from stainless steel
- Cutting bowl designed for easy cleaning
- Ergonomic handle equipped with on/o safety interlocking switch
- All cutting parts made from stainless steel or food suitable plastic
- S/steel lid easy removable for cleaning
- Led lights digital keyboard
- Pulse controls for precise cut
- Heavy duty asynchronous ventilated motor
- Belt transmission
- Safety micro switch
- All moving parts fully interlocked giving additional safety to the user
- ABS pestle
- Easy clean up
- CE approved
- Proudly Made in Italy



TAGLIAVERDURE ÉLITE

ÉLITE VEGETABLE SHREDDER



COMPLETAMENTE
SMONTABILE
COMPLETAMENTE
SMONTABILE



Alimentazione
Power supply (Volt/Hz) **230/50 230-400/50**

Potenza
Motor power (Kwatt/Hp) **0,58 (0,80)**

Produzione oraria
Production per hour (kg/h) **250-450**

Peso netto mono/tri fase
Net weight single/three phase (kg) **20,0/20,0**

TAGLIAVERDURE ÉLITE 0,58 Kw (0,80 Hp)

codice prodotto product code

Senza dischi + disco espulsore

Without discs + ejectable disc

TAGLIAVERDURE ÉLITE 0,58 Kw (0,80 Hp)

codice prodotto product code

Con dischi: E2 - E10 - D10X10 - B10 - Z3 - Z7 + disco espulsore

With discs: E2 - E10 - D10X10 - B10 - Z3 - Z7 + ejectable disc

NORME CE / CE APPROVED		SENZA NORME CE / NON CE APPROVED	
Trifase / Three phase V. 230/400	Monofase / Single phase V. 230		Monofase / Single phase V. 230
€ FTV401	€ FTV400		€ FTV400E
€ FTV301	€ FTV300		€ FTV300E

TAGLIAVERDURE ÉLITE PRO

ÉLITE VEGETABLE SHREDDER PRO



Alimentazione
Power supply (Volt/Hz) **230/50 230-400/50**

Produzione oraria
Production per hour (kg/h) **450-600**

Potenza
Motor power (Kwatt/Hp) **0,58 (0,80)**

Peso netto mono/tri fase
Net weight single/three phase (kg) **20,0/20,0**

**INGRESSO AD
ALTA CAPACITÀ**
HIGH CAPACITY INLET

TAGLIAVERDURE ÉLITE PRO 0,58 Kw (0,80 Hp)

codice prodotto product code

Senza dischi + disco espulsore

Without discs + ejectable disc

NORME CE / CE APPROVED		SENZA NORME CE / NON CE APPROVED	
Trifase / Three phase V. 230/400	Monofase / Single phase V. 230		Monofase / Single phase V. 230
€ FTV701	€ FTV700		€ FTV700E
€ FTV601	€ FTV600		€ FTV600E

TAGLIAVERDURE ÉLITE PRO 0,58 Kw (0,80 Hp)

codice prodotto product code

Con dischi: E2 - E10 - DP10X10 - BP10 - Z3 - Z7 + disco espulsore

With discs: E2 - E10 - DP10X10 - BP10 - Z3 - Z7 + ejectable disc

INTERAMENTE SMONTABILE PER MIGLIORE PULIZIA

EASE OF CLEANING WITH MANUALLY
REMOVABLE PARTS

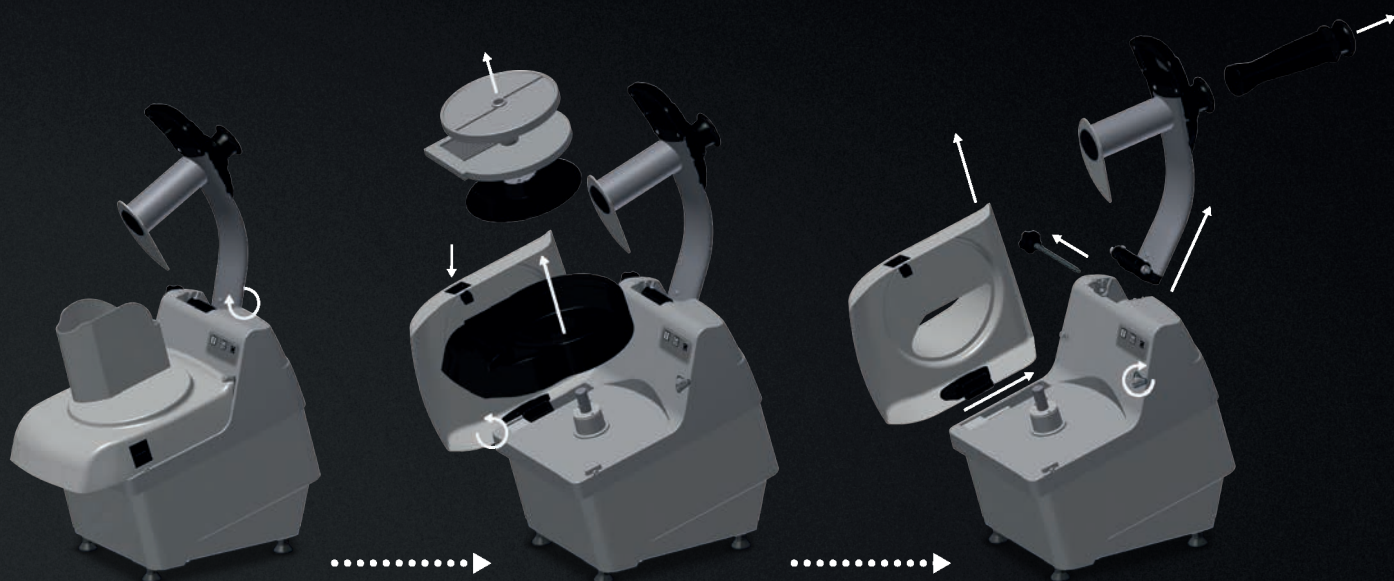

DIMENSIONI TAGLIAVERDURA ÈLITE DIMENSION ÈLITE VEGETABLE SHREDDER

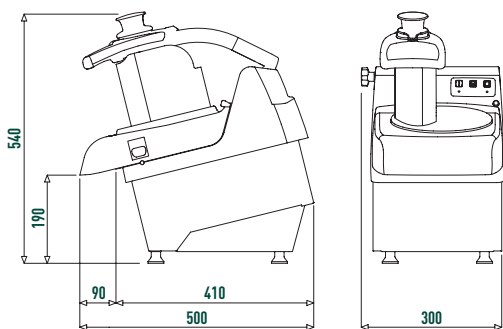

DIMENSIONI TAGLIAVERDURA ÈLITE PRO DIMENSION ÈLITE PRO VEGETABLE SHREDDER

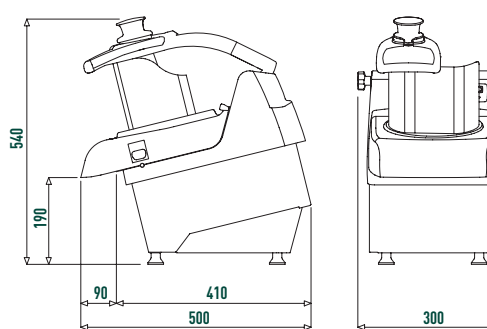

DISCHI TAGLIAVERDURA VEGETABLE SHREDDER DISCS

Tutti i dischi sono compatibili con entrambe le versioni **ÈLITE** ed **ÈLITE PRO**, ad esclusione delle serie **"B Pro"** e **"D Pro"**, adatte solo al tagliaverdure **ÈLITE PRO**

All discs are compatible with both ÈLITE and ÈLITE PRO versions, with the exception of the "B Pro" and "D Pro" series, suitable only for the ÈLITE PRO vegetable shredder

PORTADISCHI 8 PEZZI / DISK RACK 8 PIECES

CODICE	PREZZO			
FTV191	€			



X

SERIE X / X SERIES

dischi per taglio fette regolabili 1x8 da 1 a 8 mm adjustable slicing disc variable from 1-8 mm

ARTICOLO	CODICE	PREZZO		
X	FTV174	€		

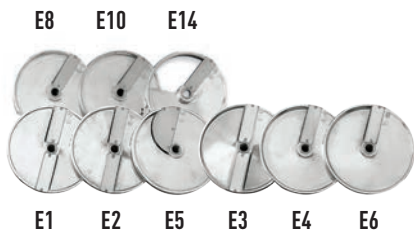

SERIE E / E SERIES					
dischi per taglio fette delicate <i>slicing discs</i>					
ARTICOLO	CODICE	PREZZO	ARTICOLO	CODICE	PREZZO
E1	FTV175	€	E2	FTV176	€
E3	FTV177	€	E4	FTV178	€
E5	FTV179	€	E6	FTV180	€
E8	FTV115	€	E10	FTV116	€
E14	FTV117	€			



SERIE S / S SERIES					
dischi per taglio fette delicate <i>slicing discs</i>					
ARTICOLO	CODICE	PREZZO	ARTICOLO	CODICE	PREZZO
S1	FTV181	€	S2	FTV182	€
S4	FTV203	€	S10	FTV204	€

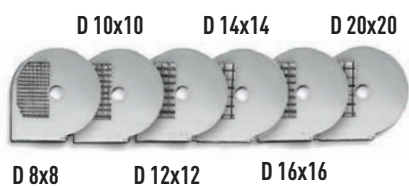

SERIE D / D SERIES					
dischi per cubettare (vanno sempre abbinati alla serie E) <i>cube cutting discs to be purchased with E disk</i>					
ARTICOLO	CODICE	PREZZO	ARTICOLO	CODICE	PREZZO
D 8x8	FTV183	€	D 10x10	FTV184	€
D 12x12	FTV185	€	D 14x14	FTV202	€
D 16x16	FTV194	€	D 20x20	FTV186	€

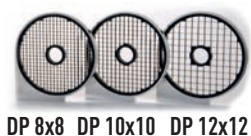

SERIE D PRO - SOLO PER ÈLITE ^{PRO} / D PRO SERIES - ONLY FOR ÈLITE ^{PRO}					
dischi per cubettare (vanno sempre abbinati alla serie E) <i>cube cutting discs to be purchased with E disk</i>					
ARTICOLO	CODICE	PREZZO	ARTICOLO	CODICE	PREZZO
DP 8x8	FTV 206	€	DP 10x10	FTV 207	€
DP 14x14	FTV 208	€			

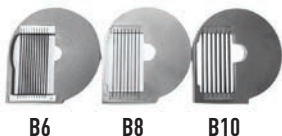

SERIE B / B SERIES					
dischi per taglio listelli (vanno sempre abbinati alla serie E) <i>chipper discs to be purchased with E disk</i>					
ARTICOLO	CODICE	PREZZO	ARTICOLO	CODICE	PREZZO
B6	FTV130	€	B8	FTV131	€
B10	FTV132	€			

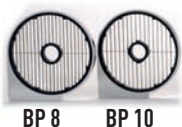

SERIE B PRO - SOLO PER ÈLITE ^{PRO} / B PRO SERIES - ONLY FOR ÈLITE ^{PRO}					
dischi per taglio listelli (vanno sempre abbinati alla serie E) <i>chipper discs to be purchased with E disk</i>					
ARTICOLO	CODICE	PREZZO	ARTICOLO	CODICE	PREZZO
BP 8	FTV 208	€	BP 10	FTV 210	€

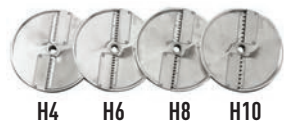

SERIE H / H SERIES					
dischi per taglio listelli ricurvi <i>staw cutting discs</i>					
ARTICOLO	CODICE	PREZZO	ARTICOLO	CODICE	PREZZO
H4	FTV187	€	H6	FTV188	€
H8	FTV189	€	H10	FTV190	€

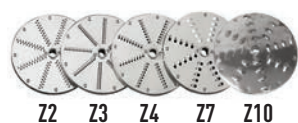

SERIE Z / Z SERIES					
dischi per sfilacciare <i>shredding discs</i>					
ARTICOLO	CODICE	PREZZO	ARTICOLO	CODICE	PREZZO
Z2	FTV118	€	Z3	FTV119	€
Z4	FTV120	€	Z7	FTV121	€
Z10	FTV199	€			



SERIE V / V SERIES					
dischi per grattugiare pane e formaggio <i>grating discs suitable for cheese and bread</i>					
ARTICOLO	CODICE	PREZZO			
V	FTV122	€			

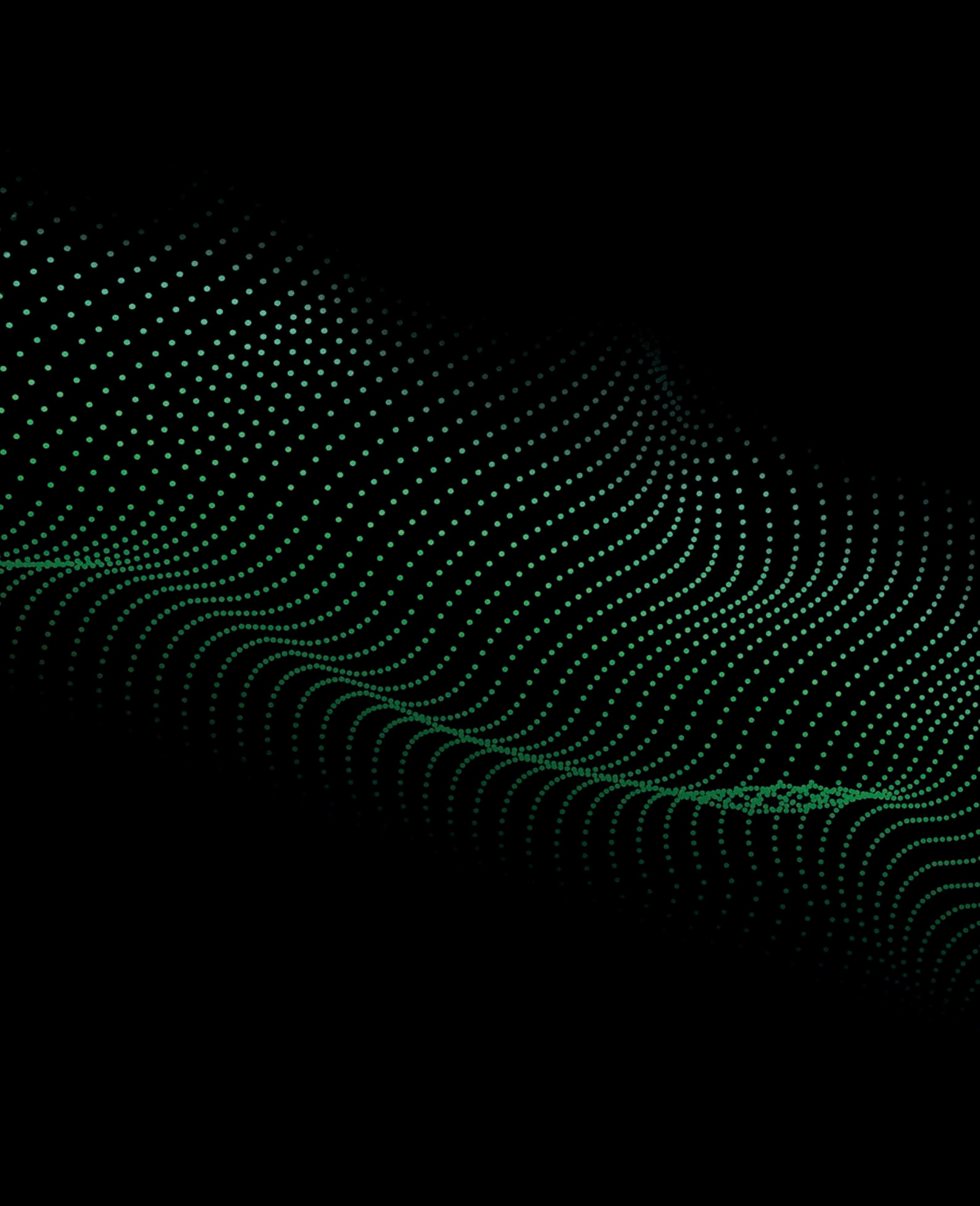

FAMA INDUSTRIE SRL
Via Altobelli, 39 - 47924 Rimini (RN)

Tel +390541.388222 - 384509
Fax +390541.385662
fama@famaindustrie.com